

# **Trends in RF/Microwave & High Speed Digital and their effect on PCB Technology Requirements**

**Jim Francey  
Technical Service Manager**



The "need for speed" is satisfied by the delivery of "high-speed broadband" transmission via telecommunication hardware. This presentation focuses on wireless & "Copper-based" systems and in particular the demands placed on PCB technology to meet very-high frequency/data-rate requirements.



On October 16, 2003 the Federal Communications Commission (FCC) announced that frequency bands from 71 to 76 GHz, 81 to 86 GHz and 92 to 95 GHz collectively referred as E-band become available to ultra-high-speed data communications. The EU followed suit in 2005. Now many parts of the world have followed US and European lead, and opened-up the e-band frequencies for high capacity point-to-point wireless, enabling gigabit-speed transmission in the millimetre-wave bands.

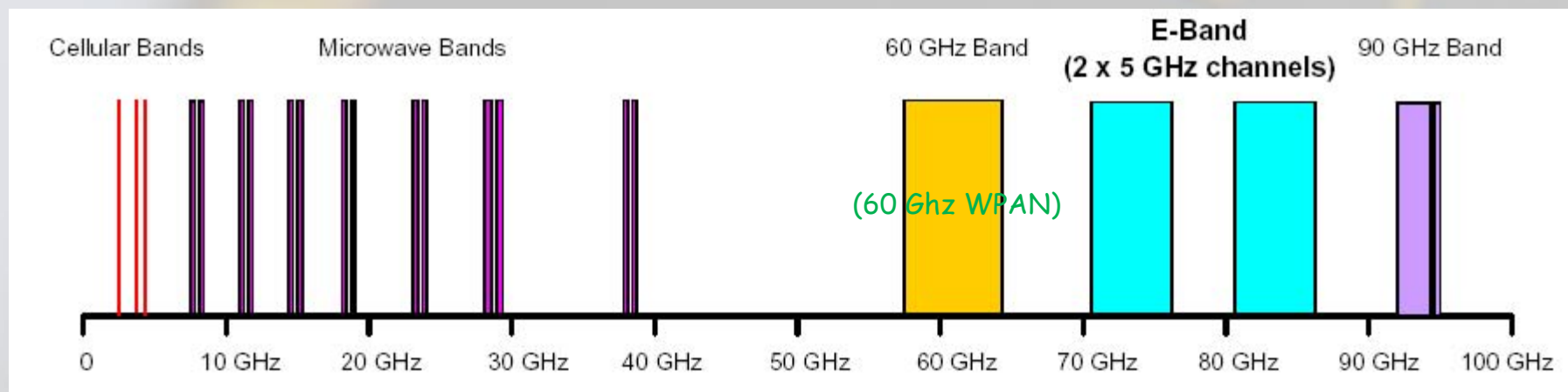

What does this mean for PCB?

There is an attraction to use PCB for say mm-wave radios over ceramic solutions (LTCC for example);

- PCB assembly economies
  - Use of conventional SMT
  - Wire-bonding "soft" substrate is maturing
- PCB global supply base
- Tooling costs are a fraction to that using ceramic

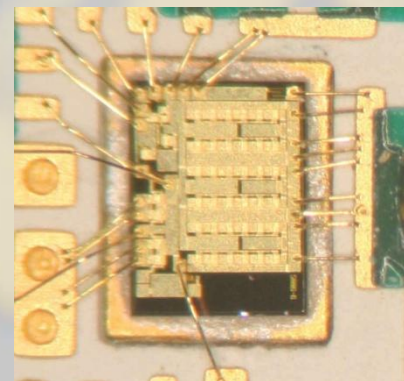

The problem with this as is true for all high frequency work is managing/minimising **loss**...

## Conductor losses

Generally speaking losses are attributed to dielectric materials and conductors. At mm-wave frequencies the losses associated with conductors are particularly true:

- "Skin Depth"

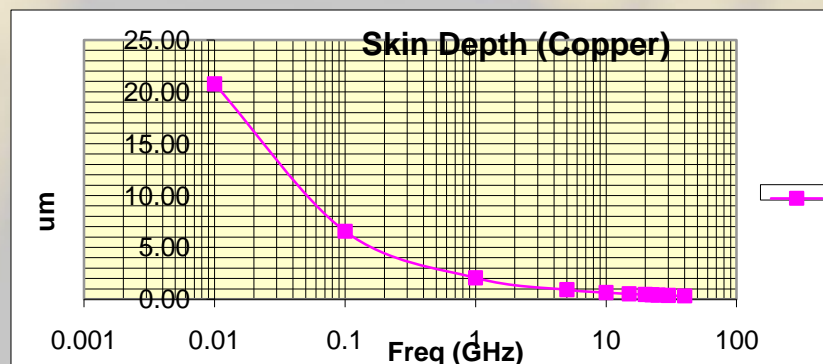

Rolled (Annealed) Copper has "lowest" surface roughness and has consistently been shown to offer lowest conductor loss.

Effect on PCB Technology: Slightly lower peel strength, softer condition more prone to surface damage.

## Conductor losses continued...

- Finish; again consider skin depth at , with the propensity of transmitted signal to "travel" on the conductor periphery the choice of metal (and its conductivity) does affect conductor loss:

	Silver	Copper	Gold	Aluminium	Nickel	Palladium
(S·m <sup>-1</sup> ) $\sigma=$	6.14E+07	5.88E+07	4.10E+07	3.53E+07	1.47E+07	1.00E+07

Consider Silver; is best conductor of any known metal.

- ASIG: Autocatalytic Silver Immersion Gold from DOW (Polymer Kompositor)
  - 0.5 $\mu$ m silver, 0.05 $\mu$ m gold
  - Universal finish including Gold/Aluminium wire bonding.

Effect on PCB Technology: Installation of Cyanide-based process & acceptance of Silver as a PCB finish (Silver migration)

## Conductor losses continued...

- Inclusion of MMIC (Monolithic Microwave Integrated Circuits)
- Length of wire (bond) is important, longer lengths lead to induction= loss.
- "Bare" MMICs usually mounted in "cavities" to keep wire length short as possible

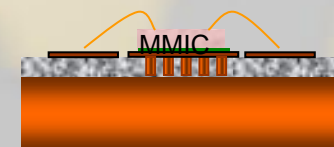
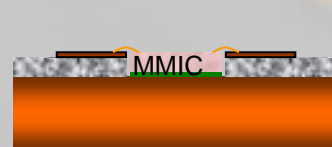
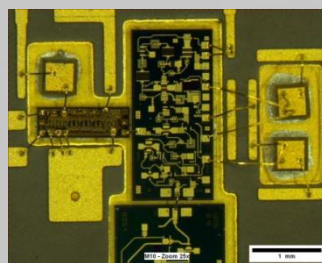
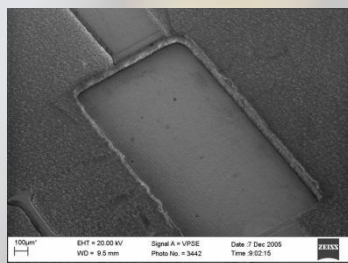
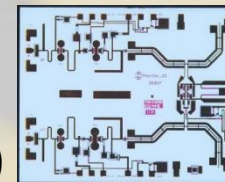

Effect on PCB Technology: Depth milling and CO<sub>2</sub>/UV laser ablation capabilities. Feature-to-feature accuracy.

## Conductor losses continued...

Related "conductor" issue as it affect mm-wave PCBs:

- Band-pass filters:
  - "Gerber portion" shows printed resonators with  $80\mu\text{m}$  gaps for 23GHz transceiver <C:\Documents and Settings\jimf\My Documents\ICT\Spie Newsroom PMMW imaging a perture synthesis.pdf>

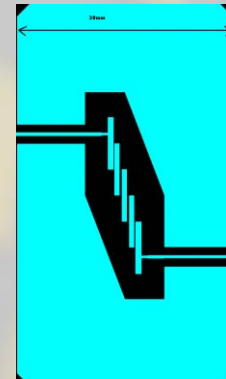

Effect on PCB Technology: Best in class imaging/etching!



*Conductor losses continued...*

Related "conductor" issue as it affect mm-wave PCBs:

- Connector launches
  - Very careful optimisation to match impedances

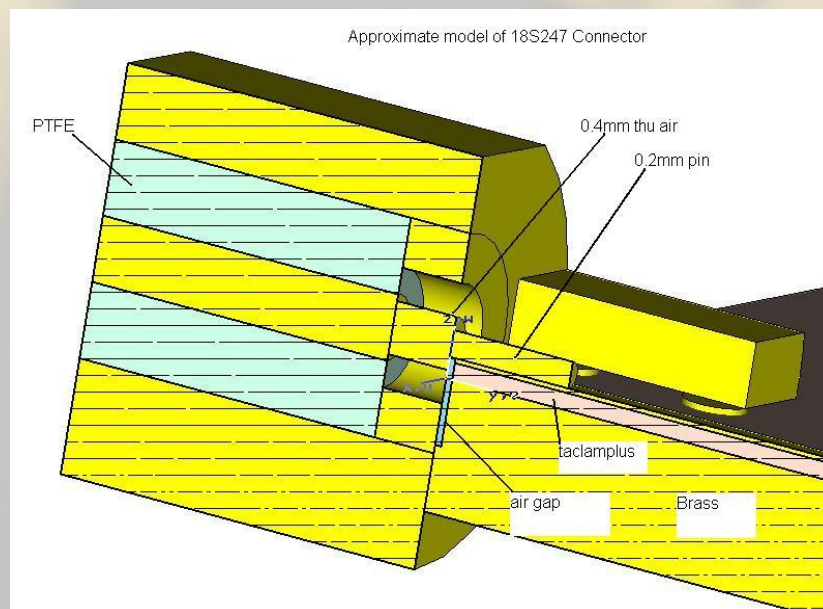

Effect on PCB Technology: Depth milling capability.

## HFSS Simulation of 50 Ohm Microstrip to Stripline Via Transition

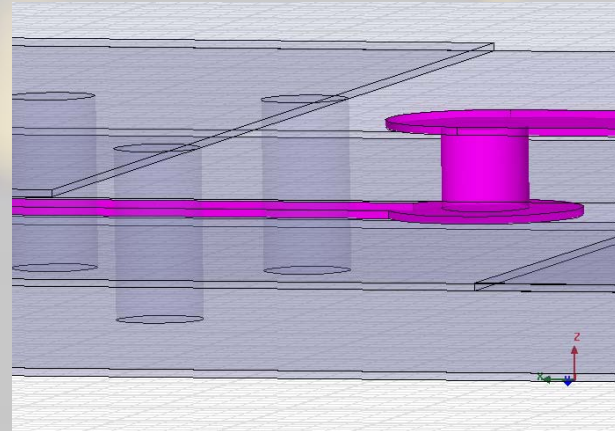
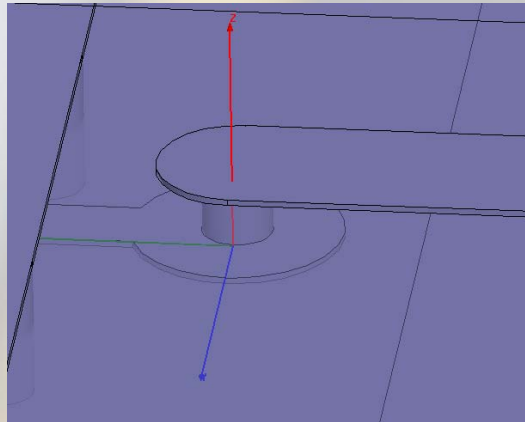

Taconic TSM-30 dielectric, each of two sections is 0.38mm in height

-1 oz Cu

-Microstrip line-width is 0.91mm

-Stripline line-width is 0.41mm

-Via diameter is 0.4mm

-Pad diameter is 0.91mm

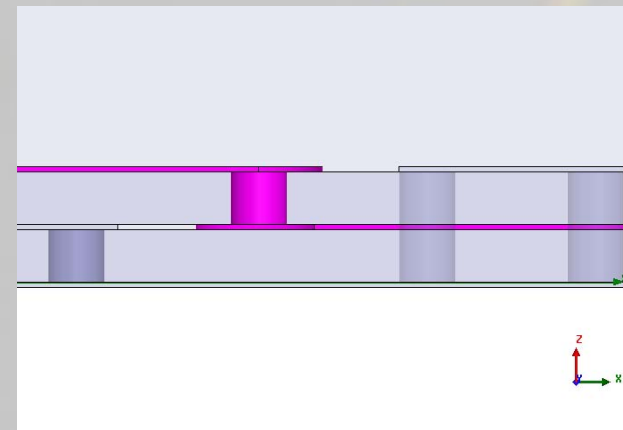

(High Frequency Structural Simulator, Ansoft Corporation)

## HFSS Simulation of Microstrip to Stripline 50 Ohm Line

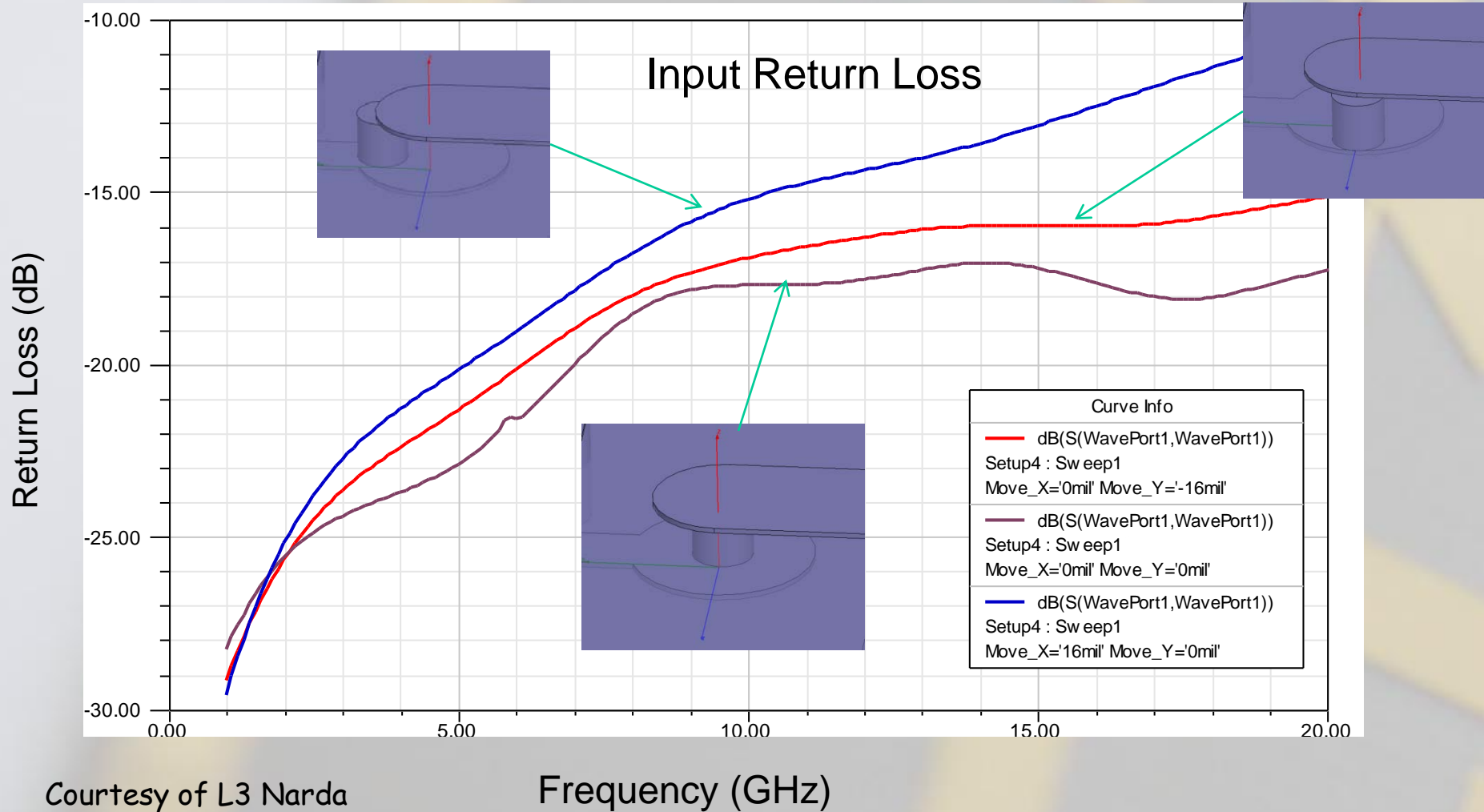

## Dielectric Material losses

It's generally accepted that low-loss materials are essential for signal integrity and signal propagation. Consider:

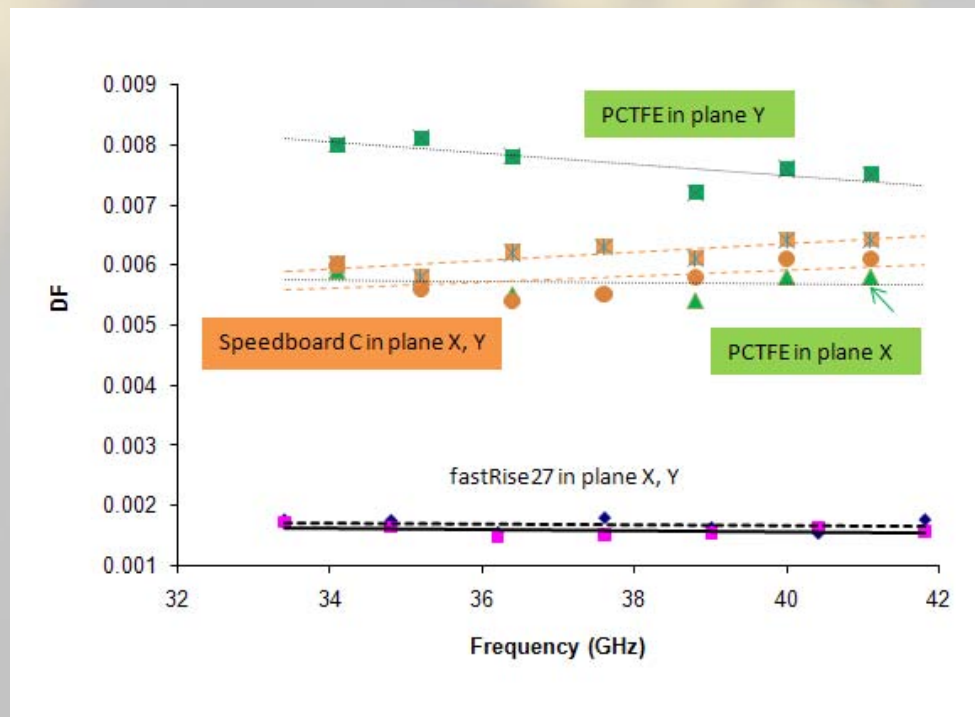

*Dielectric Material losses continued...*

Consider:

- Low-Dk materials allow designers to reduce dielectric separations for a given  $Z_0$
- For stripline, low Dk materials allow "wider tracks" for a given  $Z_0$  (and thickness).
- Wider tracks = less loss!
- Woven-glass has been shown to degrade signal integrity
  - More emphasis on "thinner" glass & thicker "ceramic/plastic"
- Consequence will be thinner/less mechanically-stable dielectric materials"

Effect on PCB Technology: More capability in "dynamic" process technologies to take account of compromised material stability!